

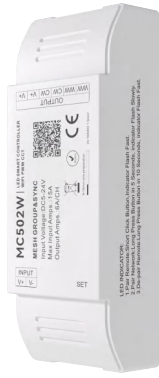

MC501W-DIM



MC502W-CCT



MC503W-RGB

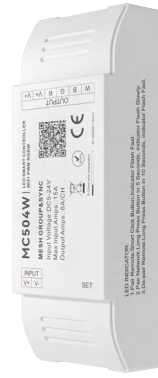

MC504W-RGBW



MC505W-RGBCCT

Compatible remote control

A single device can support 10 remote controls at the same time



MR101/DIM



MR102/CCT



MR103/RGB



MR104/RGBW



MR105/RGBCCT



MR011/DIM



MR023/3 WAY

...

Compatible voice assistants

Support language command switch, brightness, color.



Amazon Alexa



Yandex Alice



Google Assistant



已接入米家
works with
mijia



小米小爱



小智管家



天猫精灵



百度小度

Local Remote Control:

MESH remote control realizes local physical key control (such as switching, group switching, basic dimming) through MESH, which is suitable for the elderly, children or quick operation.

MSHE WIFI Controller Through the WIFI Tuya Ecology supports remote APP control, which can finely adjust brightness, color and dynamic effects, and can share devices and create groups and other functions.

peculiarity

- MESH wireless transmission technology, stable signal and strong penetration.
- Each node has a signal relay function, which makes long-distance transmission more sensitive and consumes less power.
- Support matching multiple devices, multiple devices can be controlled at the same time, and one remote control can manage and synchronize up to 500 controllers. Each controller can be supported by 10 remote controls.(Control distance 30 meters)
- The brightness of the remote control can be adjusted according to personal preference, and the brightness and speed of the dynamic mode can be edited.
- The controller can adjust the brightness, color, voice control, select various dynamic or custom scenario modes, timing, countdown and other functions through the Tuya/Smart Life APP.
- Device click to run and automate, automatic transfer and synchronization function.
- PWM (Pulse Width Modulation) technology is adopted to ensure smooth light transition and avoid eye fatigue.
- Voice control, support Asia Alexa, Google Assistant, Tmall Genie, Xiaomi Xiaoai voice assistant and other speakers.
- Support multi-controller cascade, easily cover large-area lighting scenes such as shopping malls, theaters, building facades, etc.

Device parameters

LED controllers

Input voltage	DC 5-24V
Input current	6/CH; 15A max
Access signal	WIFI
Control the distance	30M
Size	L109XW40XH26mm
Authentication	CE,ROHS

Environment

Operating temperature	Ta:-20°C~+60°C
Maximum temperature of the case	Tc:+65°C
IP rating	IP20

Wrap

Package size	L125 XW45XH30mm
Box size (100 pcs)	L26 XW24 XH16 cm

LED remote control

Voltage	3V(AAA*2PCS)
Operating current	10mW
Transmission frequency	MESH (2.4GHz)
Standby power consumption	15uA
Transmit power	6dBm
Color temperature range	3000-6000K
Remote control distance	30M
Size	L122XW53XH21mm
Operating temperature	Ta:-20°C~+60°C
Authentication	CE,ROHS

Wrap

Package size	L13XW5.8XH2.7cm/0.105kg
Box size (100 pcs)	L27XW30XH15cm/11kg

Equipment mechanism and installation

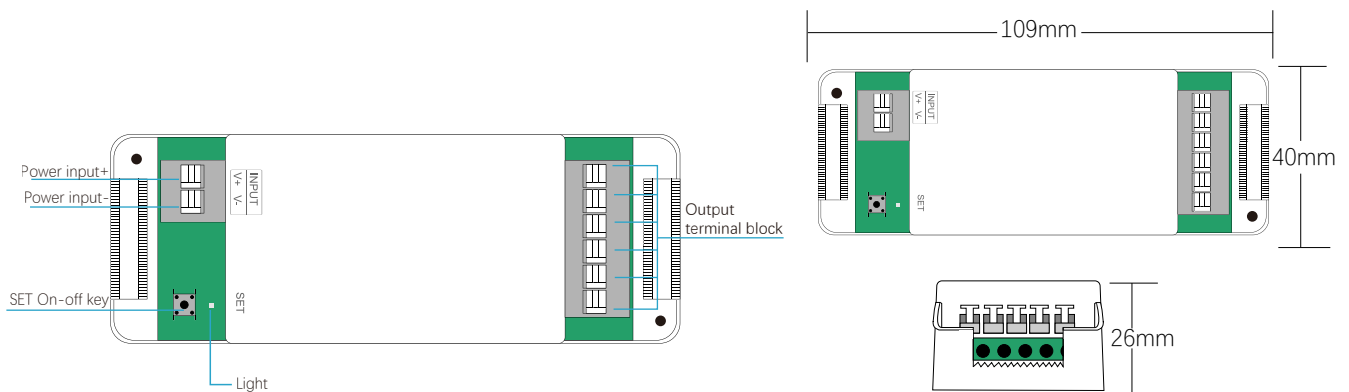

Wiring diagram of the device

Connect the strip light

AC100-240V

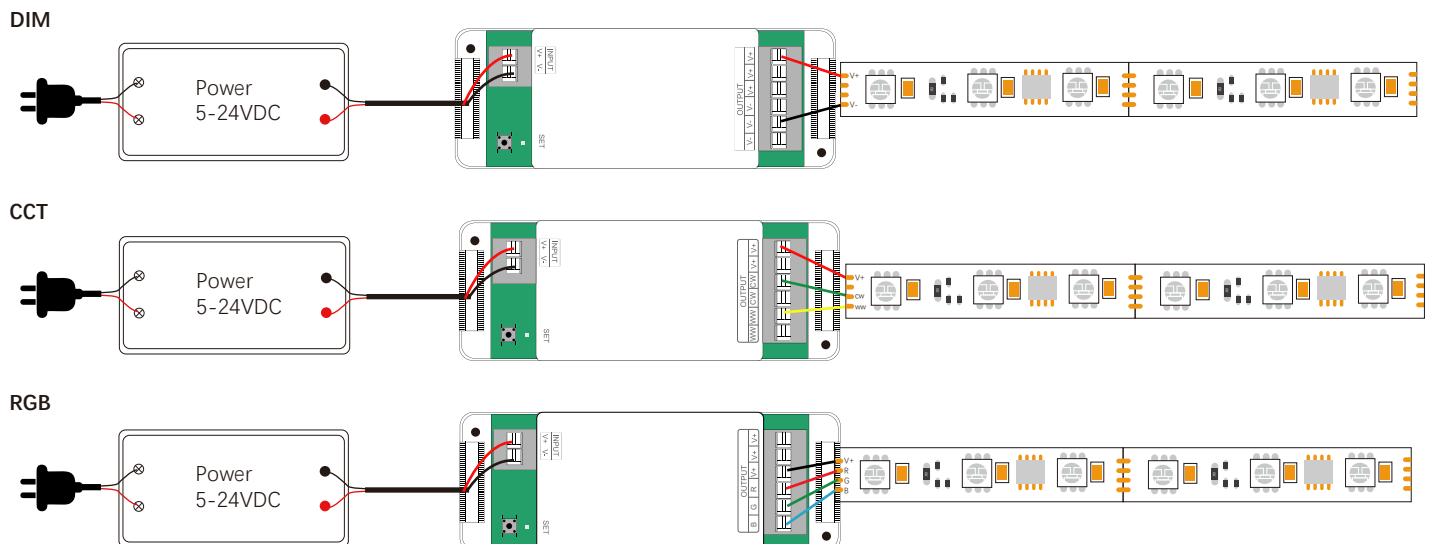

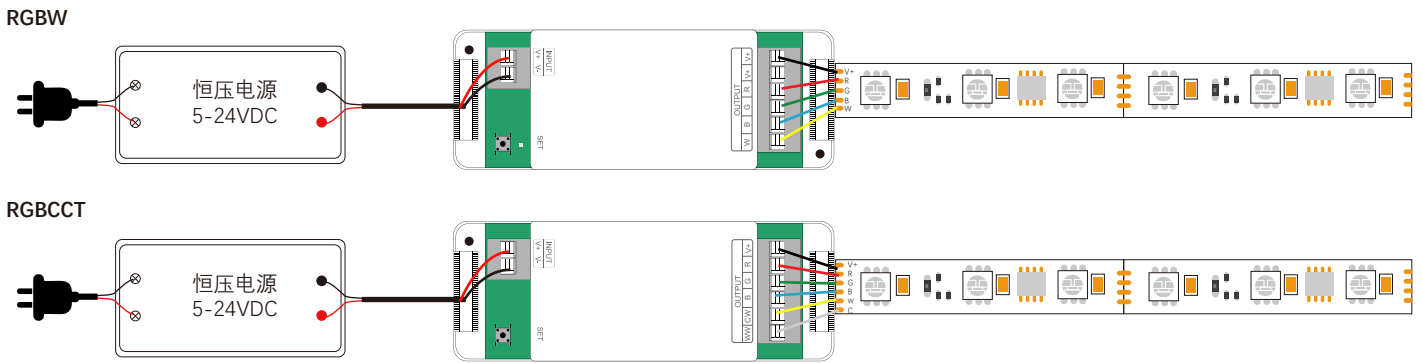

Schematic diagram of the control connection

MESH wireless communication technology

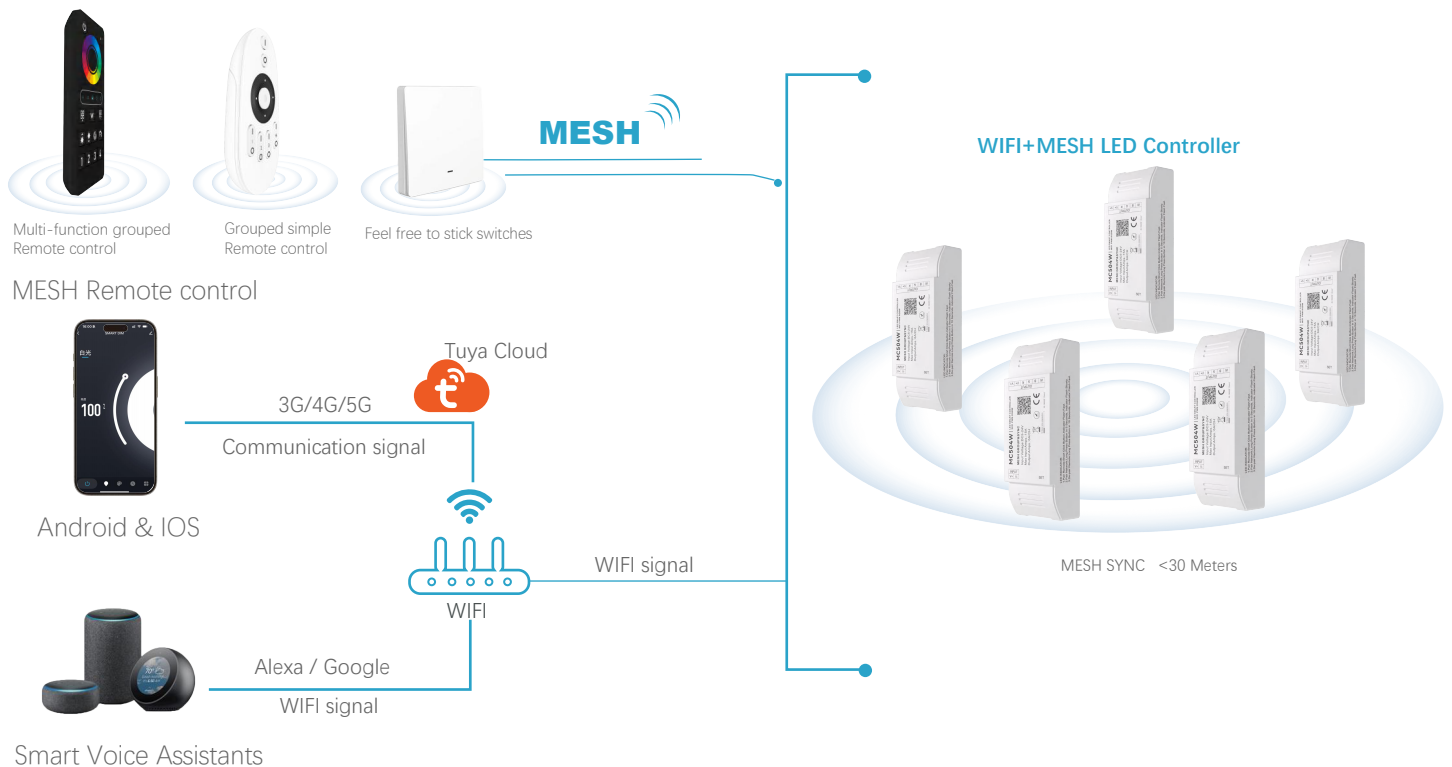

Tuya smart download & APP network connection

1. Download and install the [Smart Life] or [Tuya Smart] APP

Search for [Tuya Smart] on Apple or Google Play or scan the QR code below to download and install the app.

Please click on the "Sign Up" button to create an account and use it for the first time, if you already have an account, log in directly.

Please download the corresponding Tuya/Smart Life APP according to your region.



Scan the QR code to download the APP



Smart Life APP



Tuya Smart APP

2. Product function description & reset the device

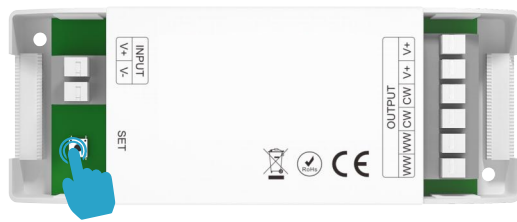

Control Method 1: 'SET'Button	Control Method 2: Power Off	Indicator light status	Next steps	Functional Result
Short press (release within 1 second)	Not supported	No special flicker	No additional action required	Switch device power on/off status
Press and hold for 3 seconds, then release	3 times	Rapid flicker	Press any group button on the remote control	Complete the pairing of the remote control with the corresponding group
Press and hold for 5 seconds, then release.	5 times	Slow blinking	Operate network settings on the mobile app	Complete the device network configuration and connect to the mobile app
Press and hold for 10 seconds, then release.	10 times	Rapid flicker	No additional action required	Device reset, clear WiFi network information and remote control pairing

2.2-1.Adjust the controller frequency

- Press and hold the "SET" button of the controller, let go after the indicator light flashes quickly, and wait for the indicator light to stop flashing.This stage is the preparation stage for frequency switching
- The indicator light stops flashing, and immediately press and hold the "SET" button again (enter the frequency selection stage):
 - When the indicator light turns to flicker slowly, let go immediately and the controller frequency is switched to 1kHz;
 - If the indicator light flashes quickly, let go immediately, and the controller frequency is 16kHz.

1. Make sure your smartphone is working under a WLAN network.
2. Open the login APP, press and hold "SET" to add a device, if it is not found, please click " " in the upper right corner, and then manually select "Add Device", when adding, you need to enter the WiFi password of your smartphone connection, and wait for 5-10 seconds to complete the connection after successfully entering
3. Once the connection is successful, the new device will be displayed on the home page, then tap on the device and enter the control interface to do more

Follow these steps to complete the connection:

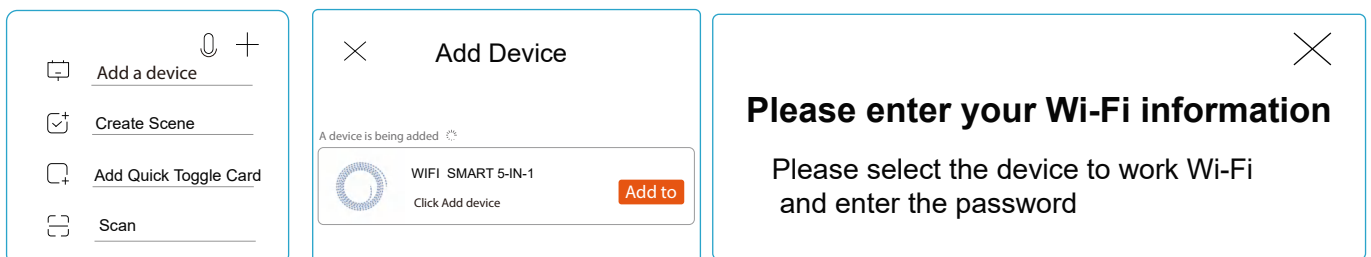

Tuya APP interface

Main interface: white light mode; color temperature mode; IPL mode; Color light mode+ White light mode; Color light mode+ color temperature mode;



white light mode
DIM



color temperature mode
CCT

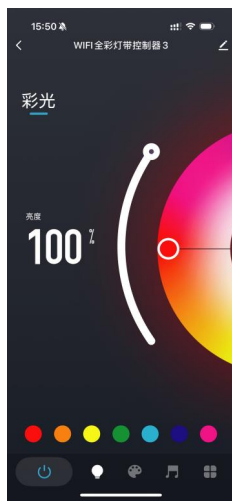

IPL mode
RGB

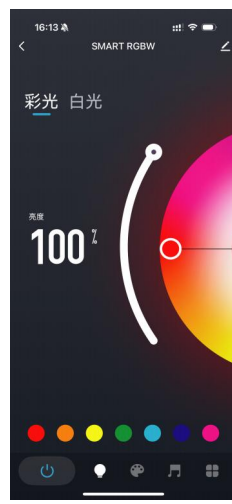

Color light mode+
White light mode
RGBW

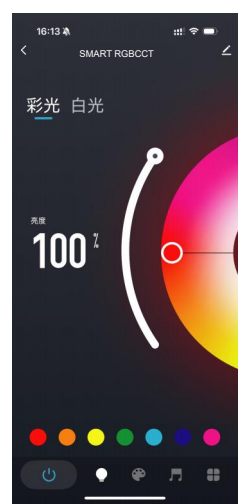

Color light mode+
color temperature mode;
RGBCCT

MC501、MC502 Tuya app interface



Scenario mode

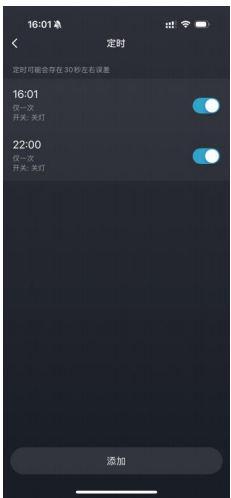

Timing

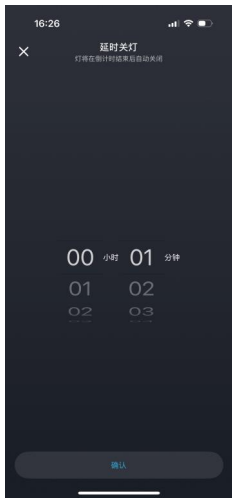

Countdown



Power-off mode



Set up

White light mode/color temperature mode: one-key switch, basic dimming

Custom Scenes: Six Scenario Modes Customize the static, jumping, breathing, color, brightness, and transformation speed of the scene, a total of 4 scenes can be customized.

Timing: Customize multiple times to perform on/off light actions. There may be an error of about 30 seconds in timing.

Countdown: Customize the countdown time to perform the on/off action of the lights, and the lights will automatically turn off after the countdown ends.

Power-off memory: Power-on reaction can set the state of the light after power-on.

Settings: This interface can be bound with third-party language control, one-click execution and automation, group creation, device sharing and other functions

MC503、MC504、MC505 Tuya app interface

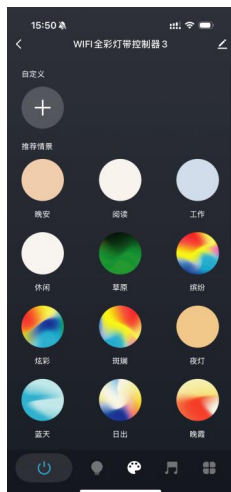

Scenario mode

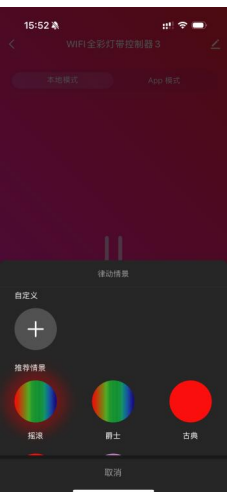

Music mode

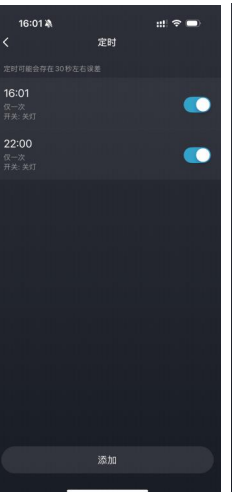

Timing

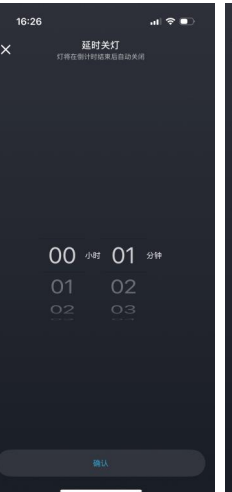

Countdown



Power-off mode



Set up

IPL mode/IPL&White mode/IPL&color temperature mode: one-key switch, IPL: set the color and brightness of the light, one-key shortcut color. White Light: Set the brightness and color temperature of white light.

Custom scenes: 32 story modes (30 story modes in RGB) Custom custom can adjust the static, jumping, breathing, color brightness, and change speed of the scene, a total of 10 scenes can be customized.

Music Mode: Local Mode: Adjustable Sensitivity, 5 Recommended Scenes, Custom Rhythm Scenes, a total of 3 Custom Rhythm Scenes can be added. APP mode: the sensitivity is not adjustable, you need to turn on the mobile phone microphone to detect the music.

Timing: Customize multiple times to perform on/off light actions. There may be an error of about 30 seconds in timing.

Countdown: Customize the countdown time to perform the on/off action of the lights, and the lights will automatically turn off after the countdown ends.

Power-off memory: Power-on reaction can set the state of the light after power-on.

Settings: This interface can be bound with third-party language control, one-click execution and automation, group creation, device sharing and other functions

Description of the function of the remote control

Multi-function grouped Remote control

🔘 Main ON/OFF button 1 2 3 4 Grouping key Short press; Select the key function. Long press; Perform key functions.

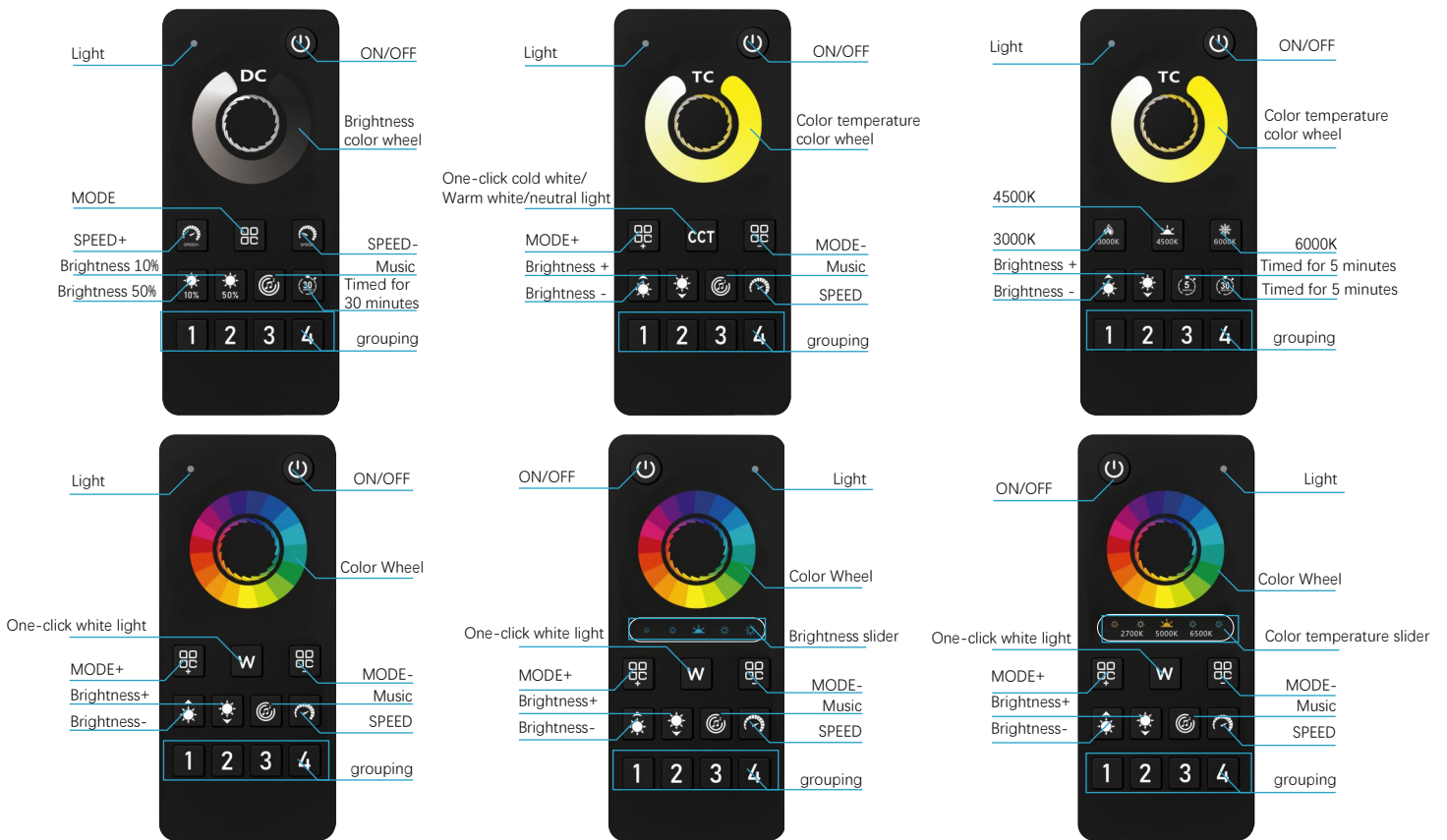

Grouped simple Remote control

Feel free to stick switches

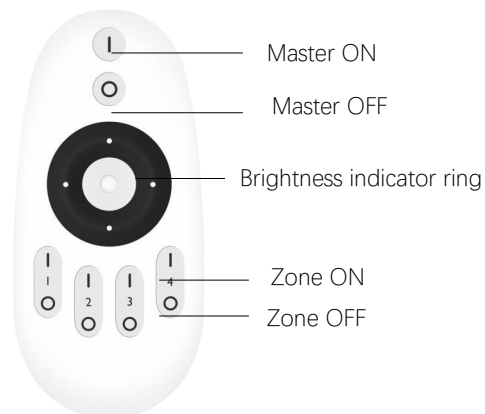

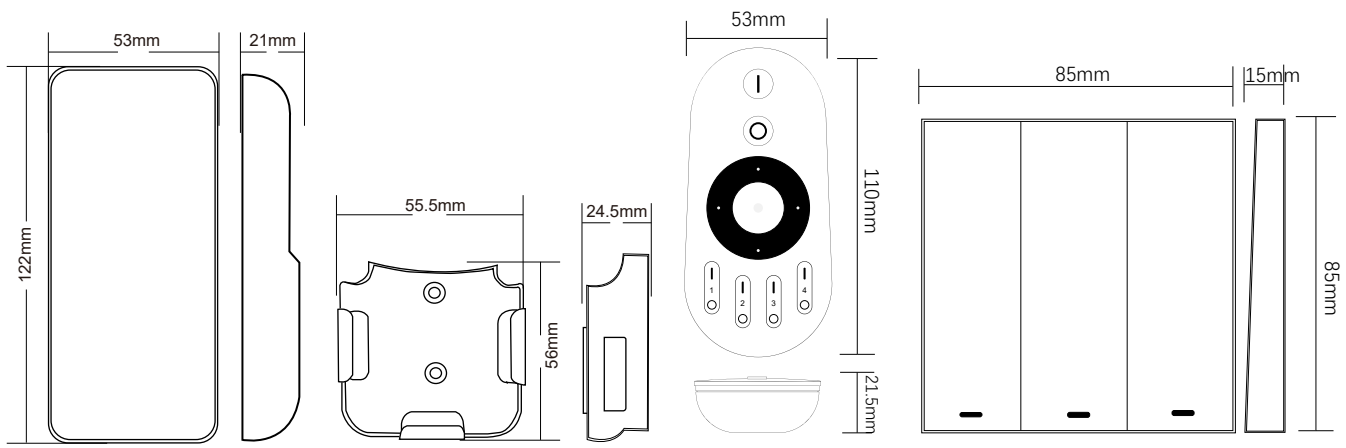

Safety Precautions

1. The remote control is a precision electronic product, please do not use it in a humid or high temperature environment for a long time. If not in use for a long time, remove the battery and store it in a cool, dry place.
2. Do not use this device in a large area of metal or in an environment with strong electromagnetic waves nearby, otherwise it will seriously affect the control distance
3. Please check whether the input voltage of the constant voltage power supply meets the requirements of the controller, and check whether the connection of the cathode and anode is correct.
4. The working voltage is DC 5~24V, if the voltage is higher than 24V, the controller will be damaged.
5. Non-professional users cannot directly disassemble the controller, otherwise it may cause fire and electric shock.
6. The working temperature (Ta) is -20~60°C; Do not use the device in direct sunlight, humidity, or other high-temperature areas.
7. When the equipment load reaches 15A, the wire diameter must be more than 1.5 square millimeters
8. When the device load exceeds 10A, the connection cable from the DC port to the LED strip must be shorter than 40cm.
9. Please install the device in a good heat dissipation area.